

Component Guide

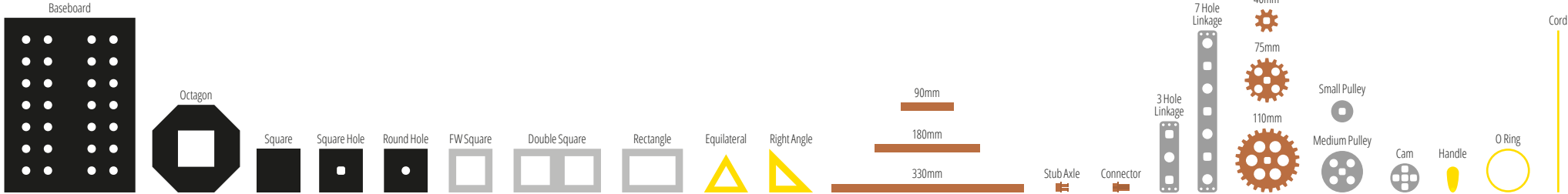

Square Hole



Round Hole



Stub Axle



Connector

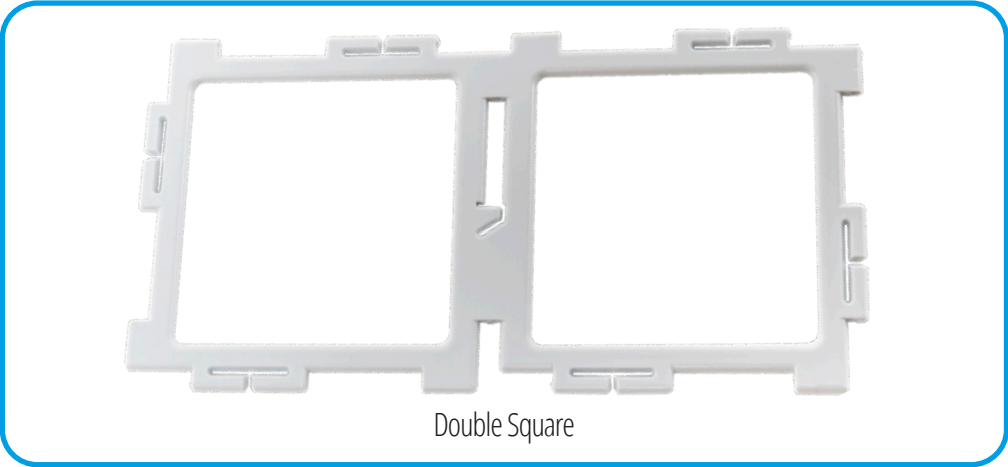

Double Square



Medium Pulley



Cam

Cable Car

**ORIGINAL
POLYDRON**

1



1



4



5

2

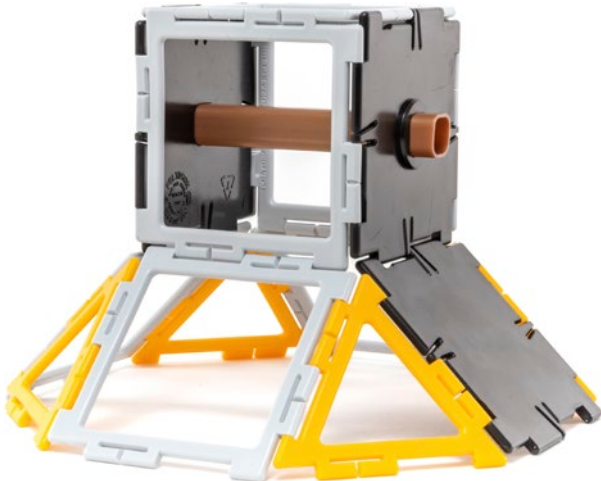

4



6



1

Square Hole



2

90mm

1

3



2

Medium Pulley



2

Connector



1

Stub Axle

2

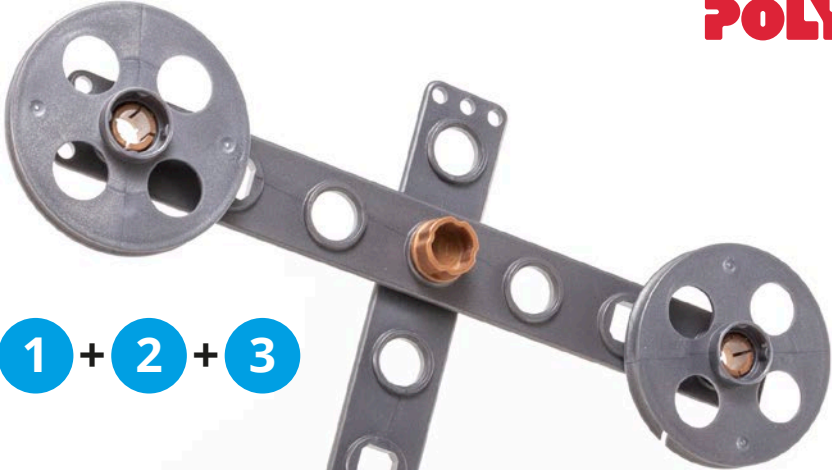

1 + 2 + 3



Gear Toy 1

1

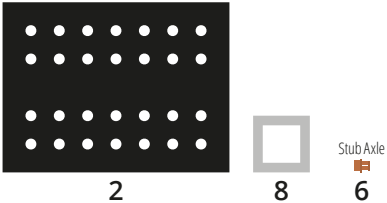
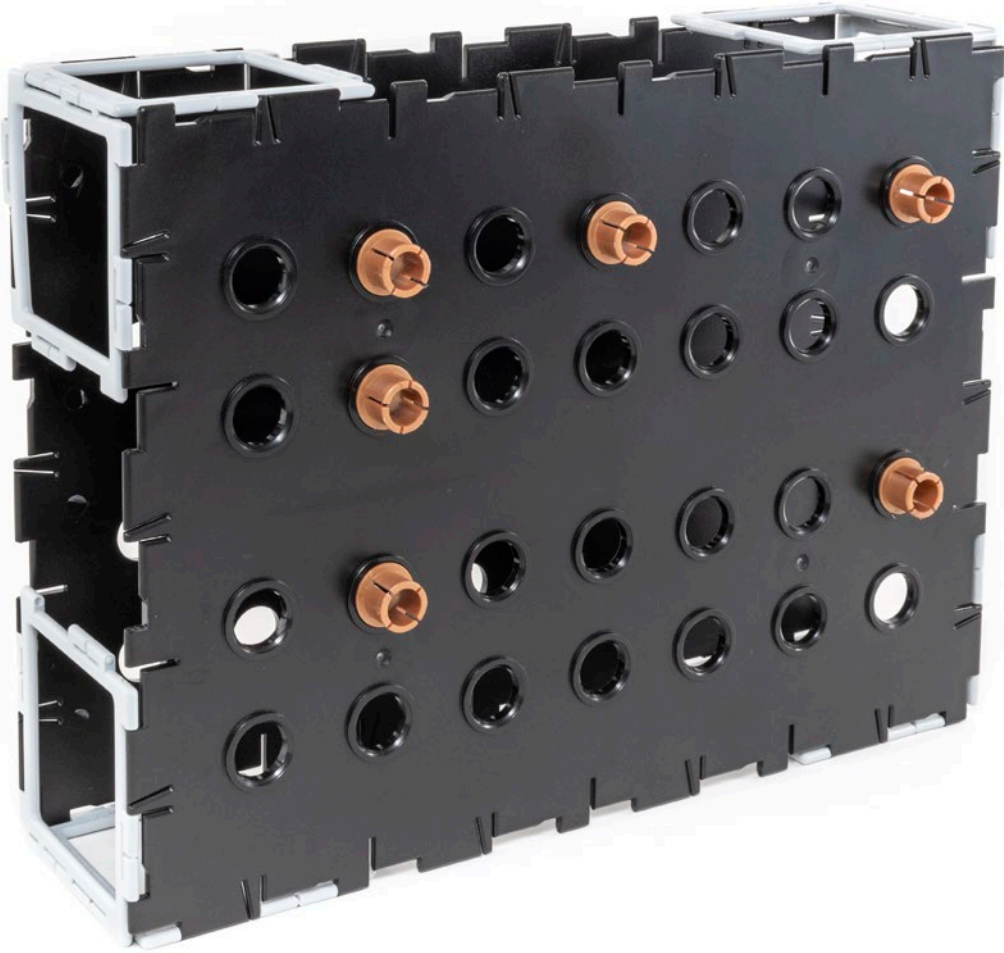

2

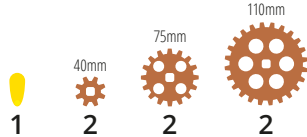
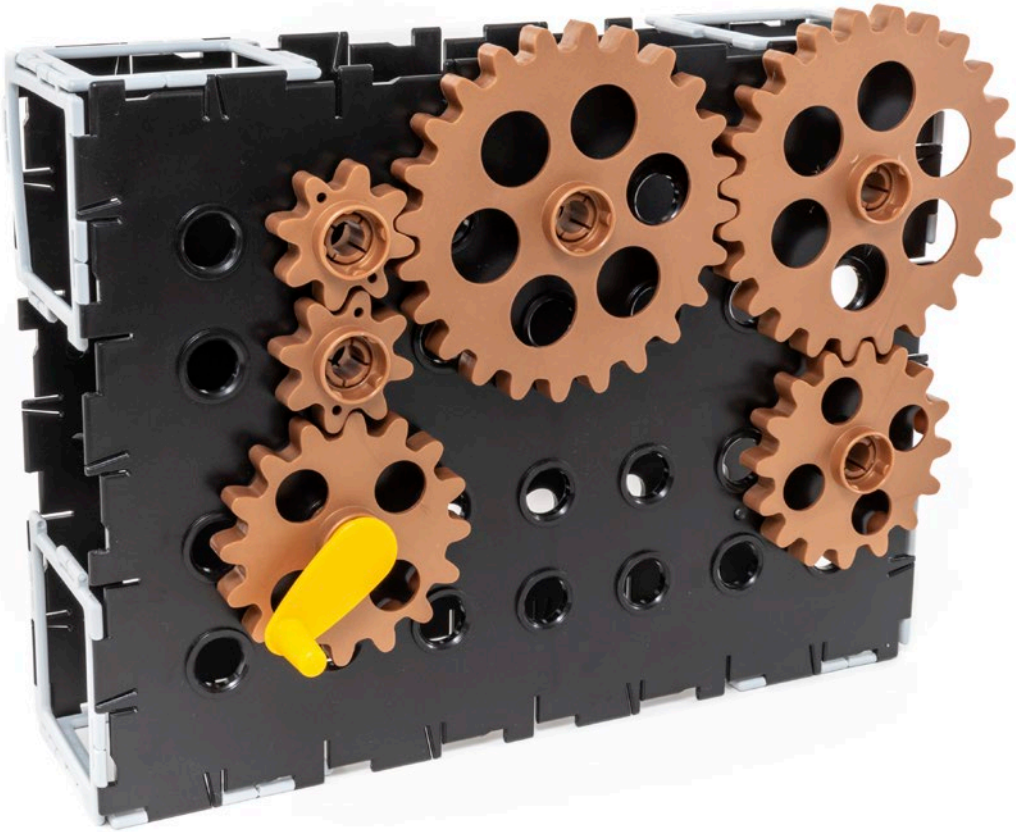



Gear Toy 2

1



- 

2
- 

8
- 

Stub Axle
6
- 

Connector
2
- 

1

2

ORIGINAL
POLYDRON

- 

1
- 

1
- 

Small Pulley
1
- 

Medium Pulley
1
- 

40mm
2
- 

75mm
1
- 

110mm
2

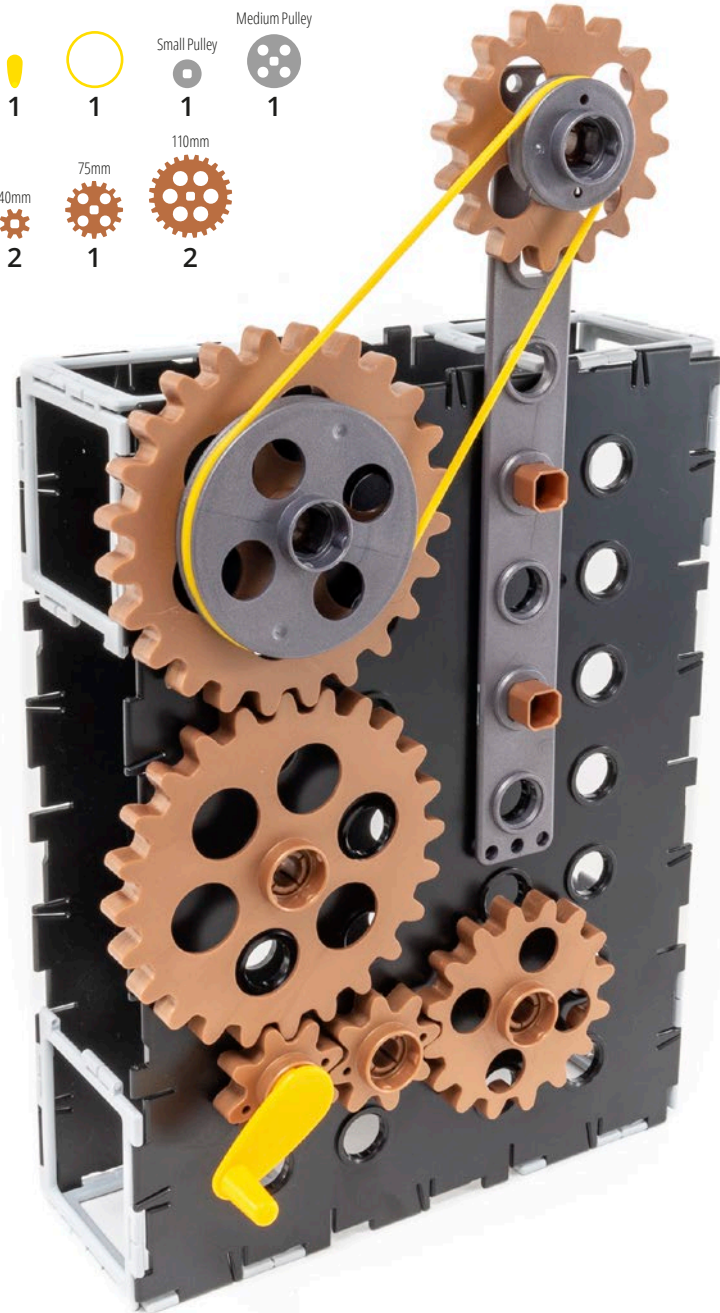

Chairspinner

1

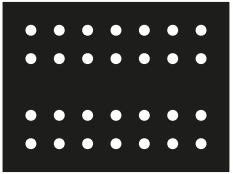
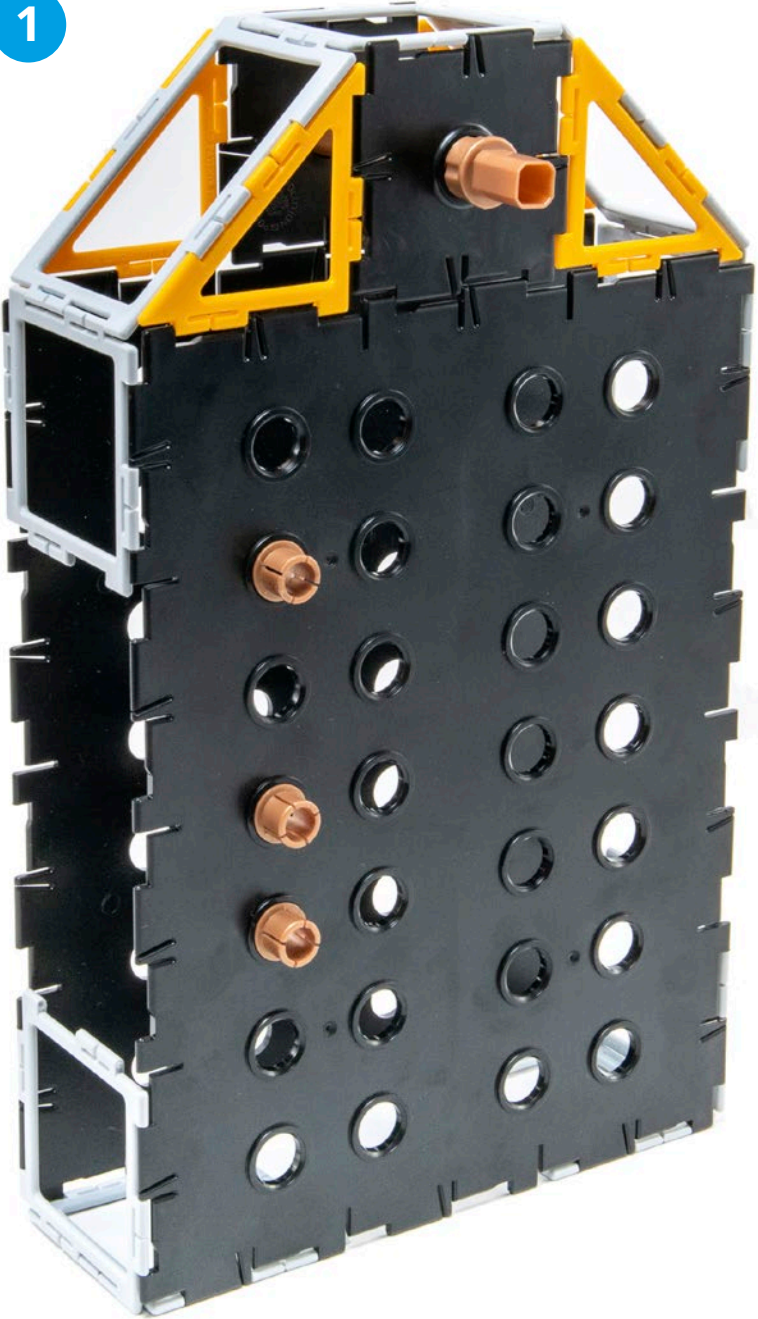

2

Round Hole



2



7



4



2

Connector



2

90mm



1

Stub Axle



3

2



1



1

Medium Pulley



2



40mm



110mm



1

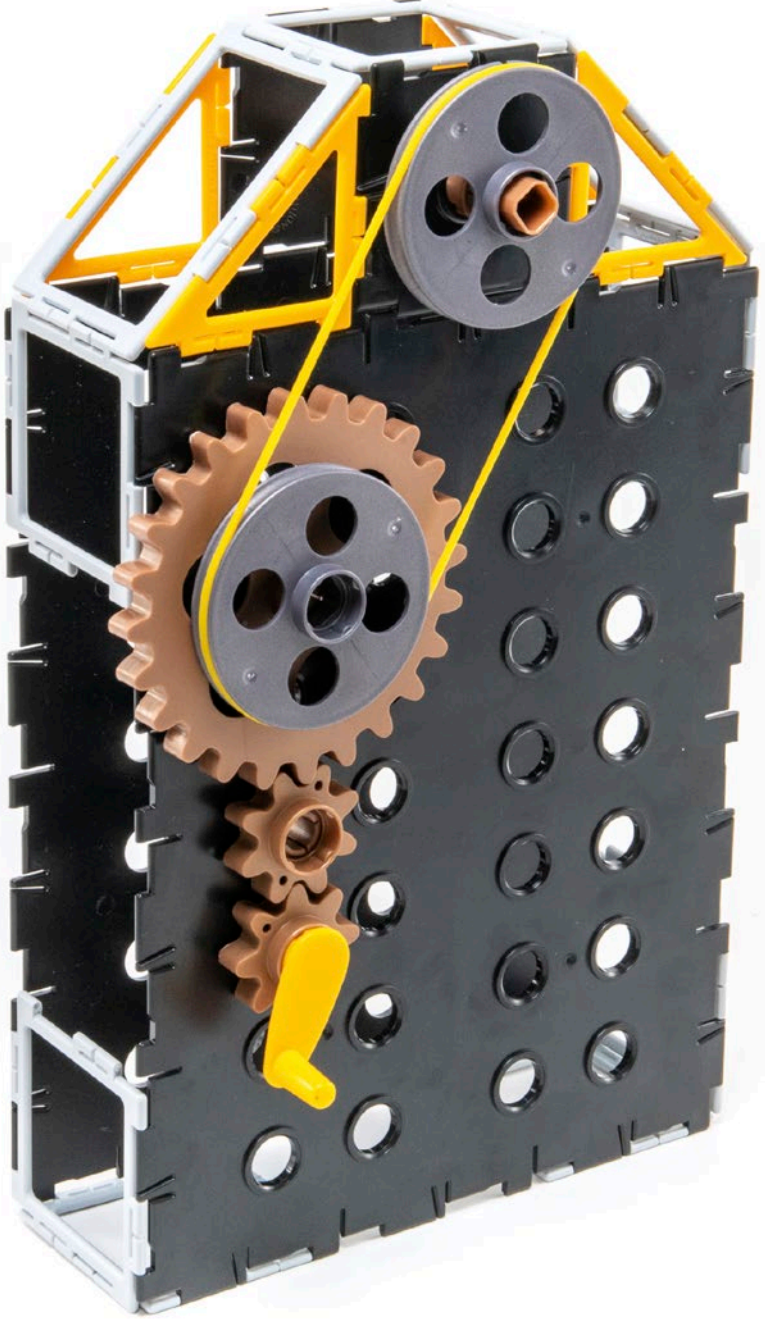

3



-  2
-  2
-  Square Hole 2
-  4
-  3
-  Connector 4



2 + 3

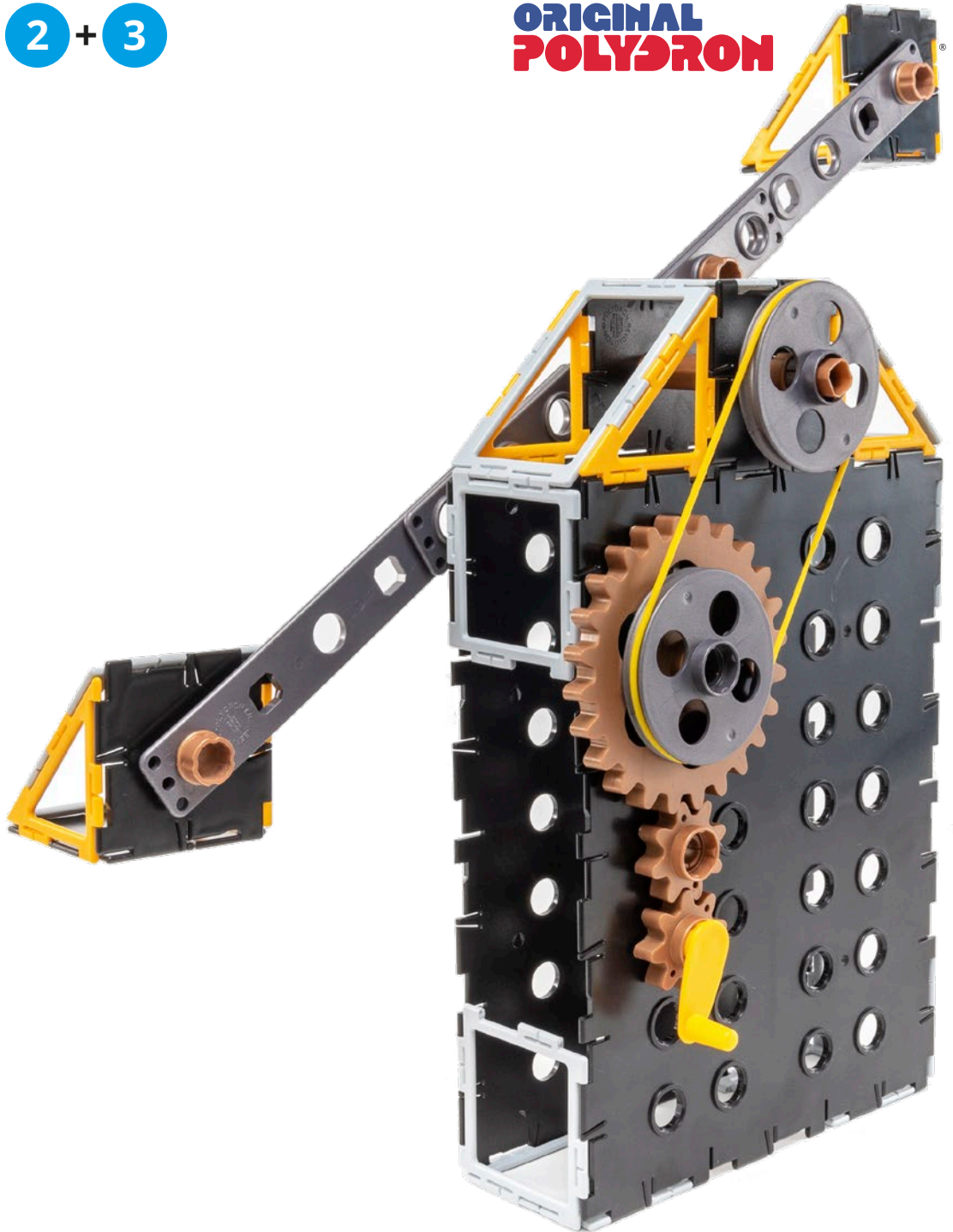

ORIGINAL
POLYDRON

Chairoplane

**ORIGINAL
POLYDRON**

1

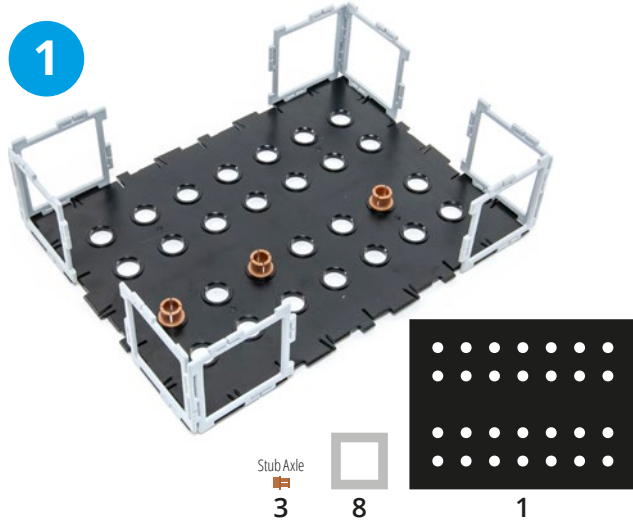

3

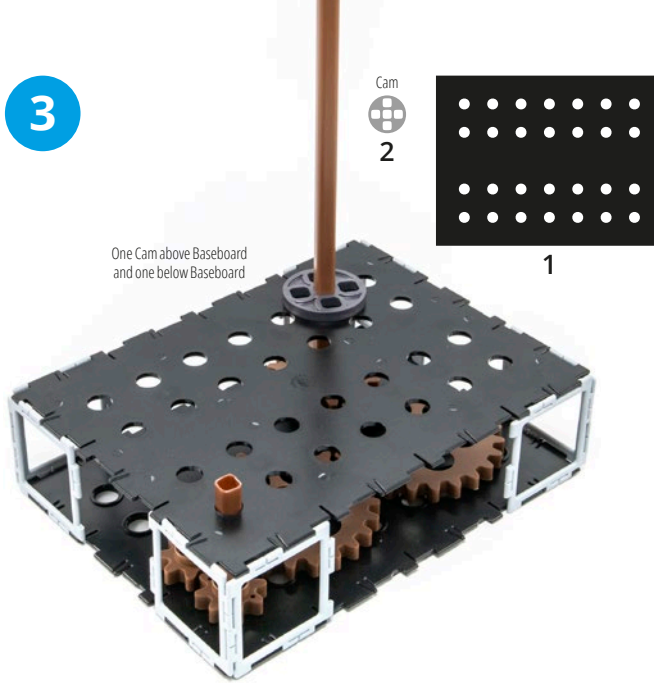

5

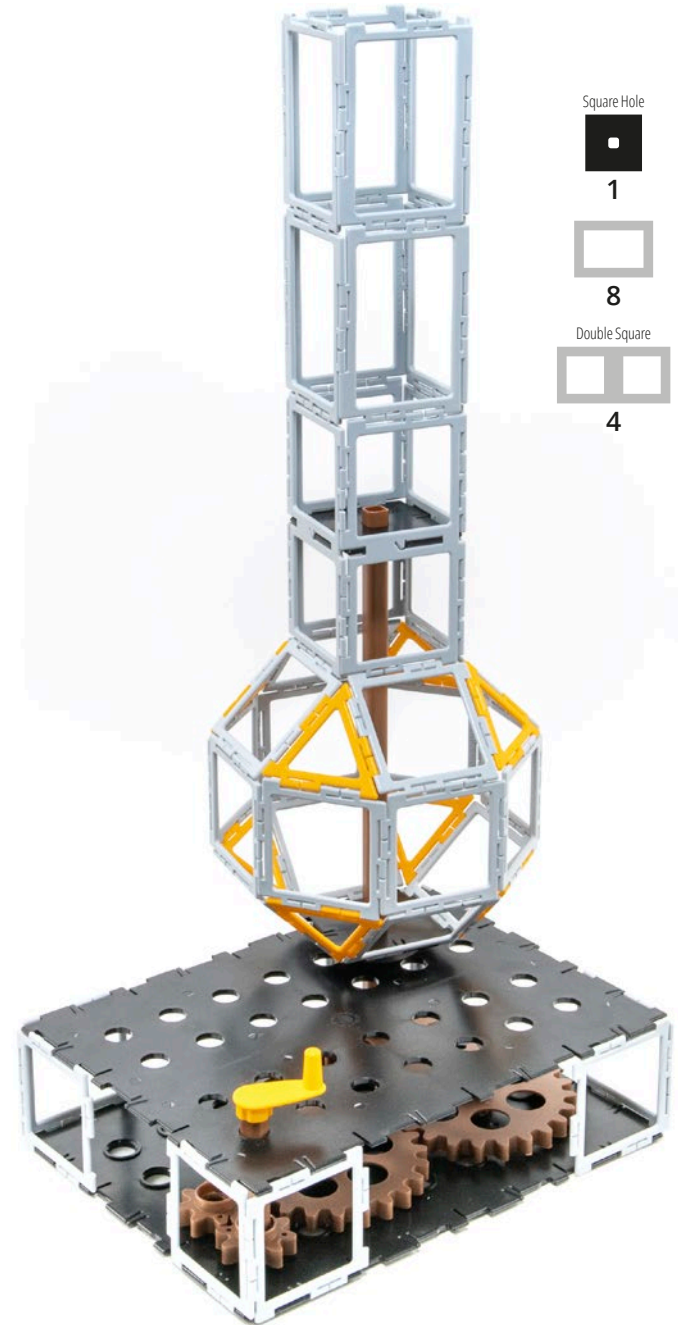

2

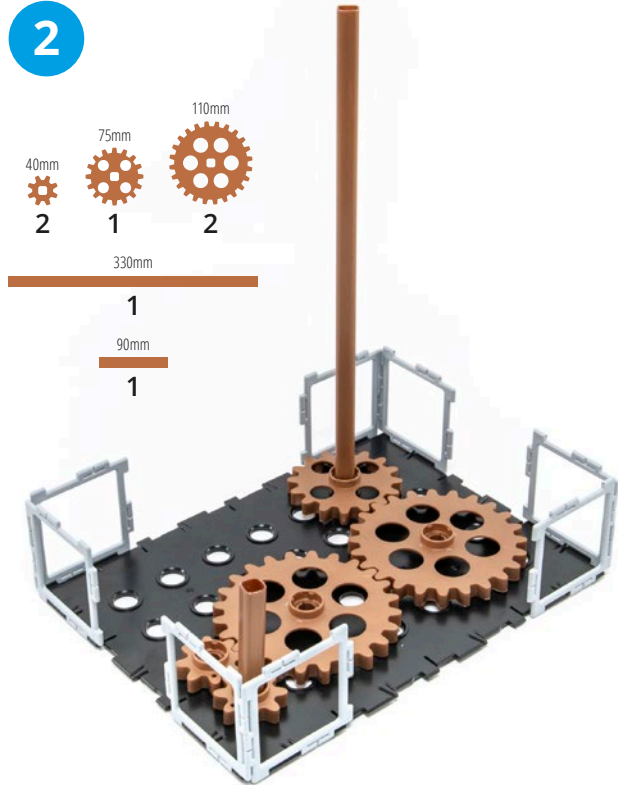

4

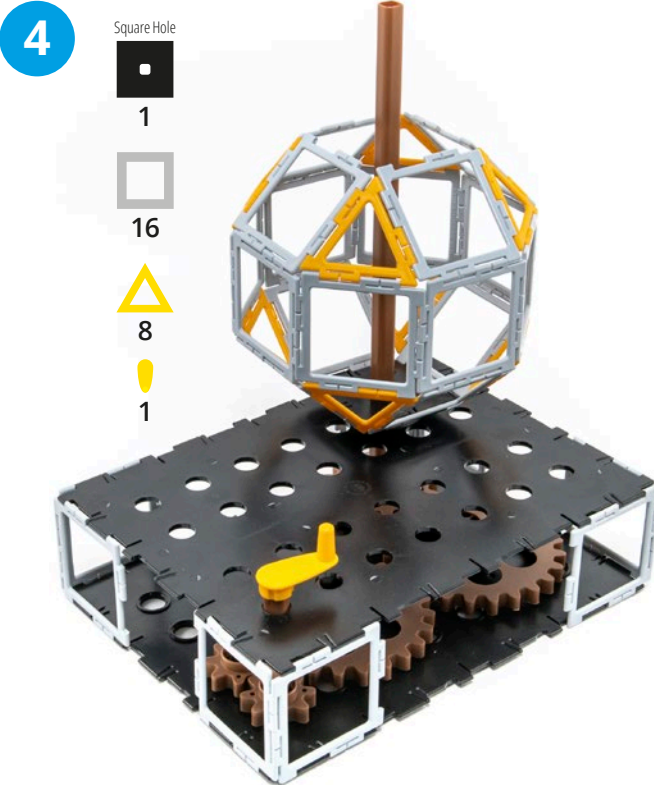

6



- Square Hole
- 1
 - 1
 - 1
 - 2
 - 1
- Connector
- 1



7



- Connector
- 1
- Square Hole
- 1

8 = 6 + 7

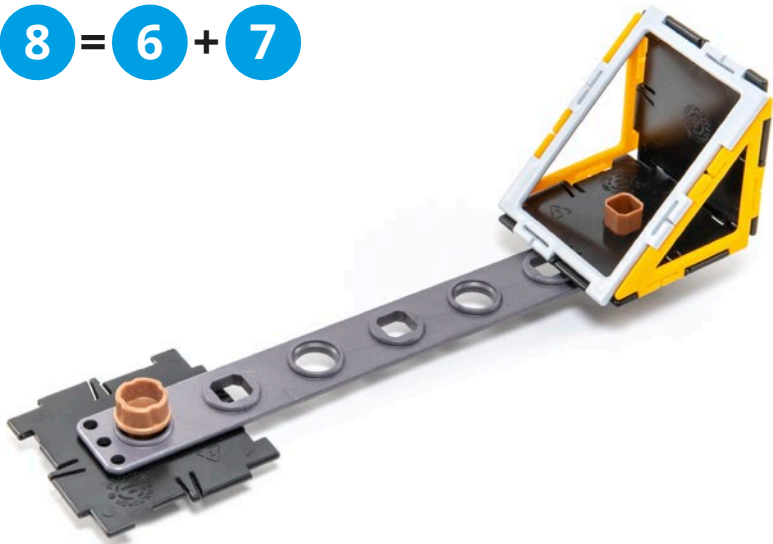

5 + 4 x 8

